

A_FS_TB-ST-2FLG_SH_STU_FS-30-2-LA.pdf

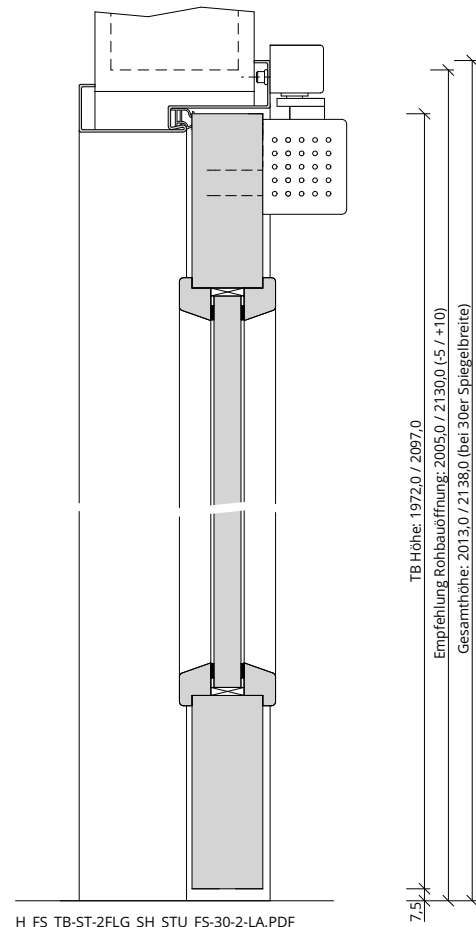

H_FS_TB-ST-2FLG_SH_STU_FS-30-2-LA.PDF

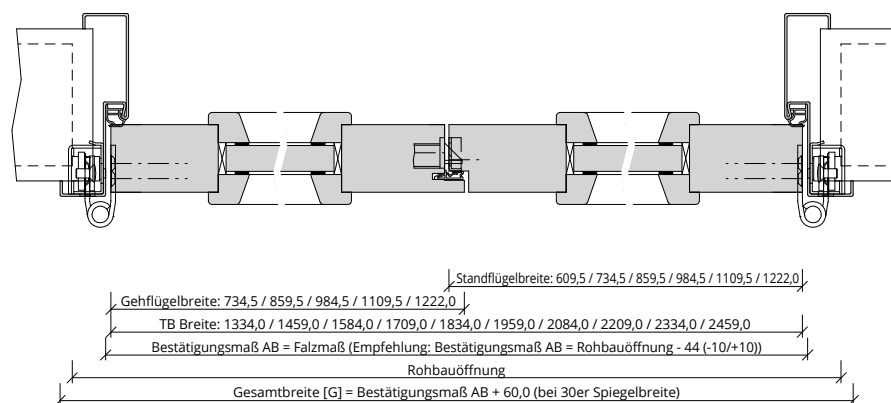

Q_FS_TB-ST-2FLG_SH_STU_FS-30-2-LA.pdf

