

A_FS_TB-BLO-2FLG_WF4_GEF_FS-30-2-LA-RD.pdf

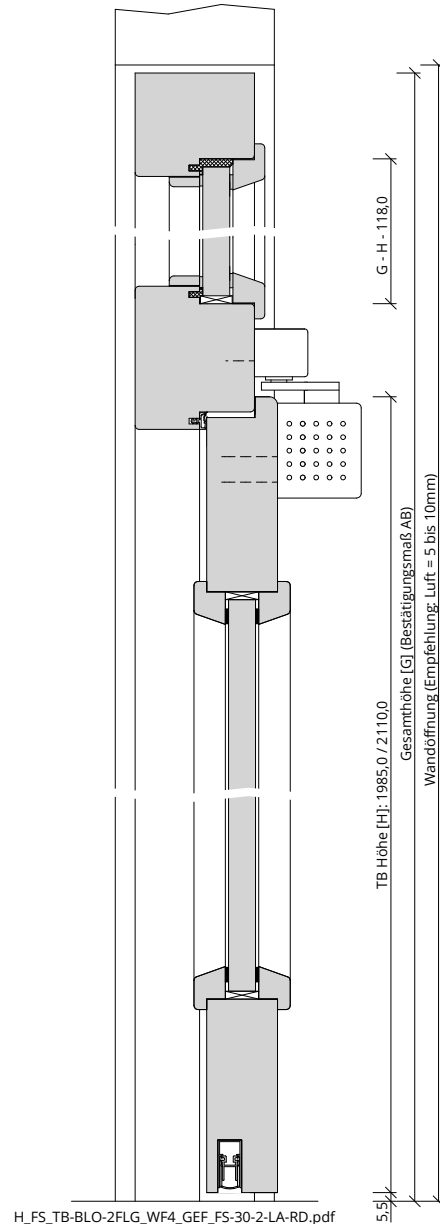

H_FS_TB-BLO-2FLG_WF4_GEF_FS-30-2-LA-RD.pdf

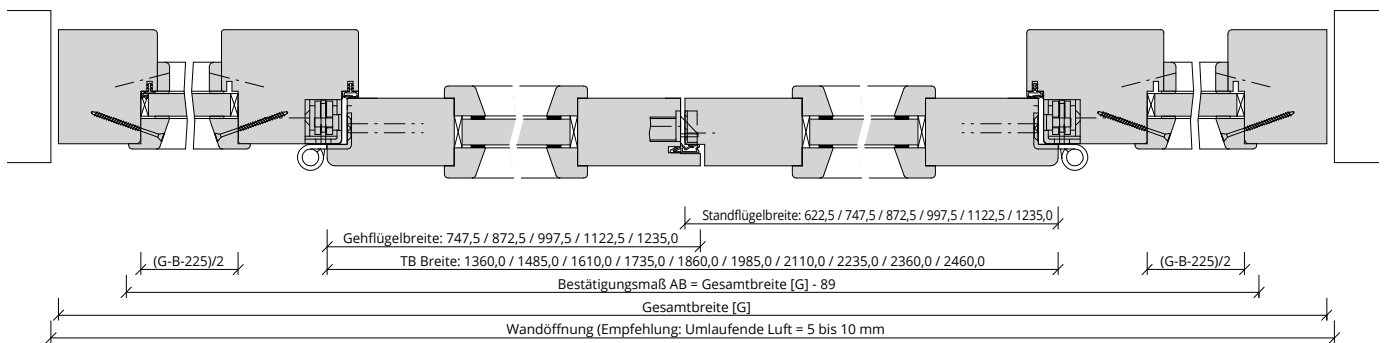

Q_FS_TB-BLO-2FLG_WF4_GEF_FS-30-2-LA-RD.pdf

