

A\_DT-WF\_WF3\_TB-LA\_ST\_GEF-1FLG.PDF

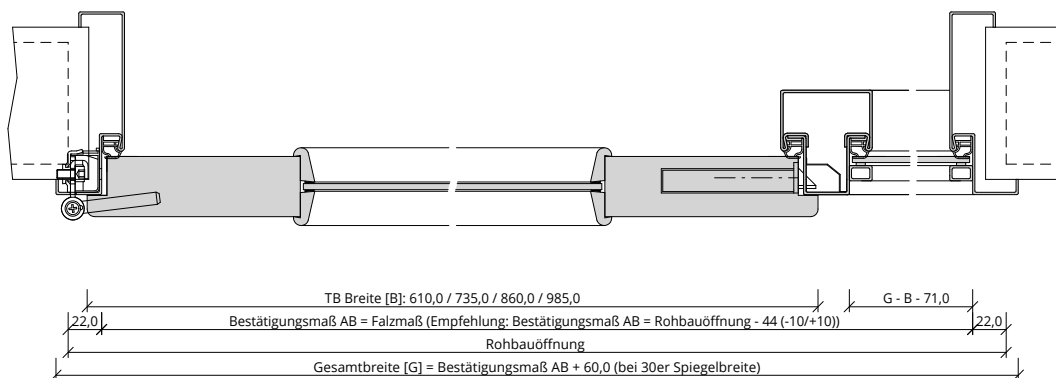

Q\_DT-WF\_WF3\_TB-LA\_ST\_GEF-1FLG.pdf

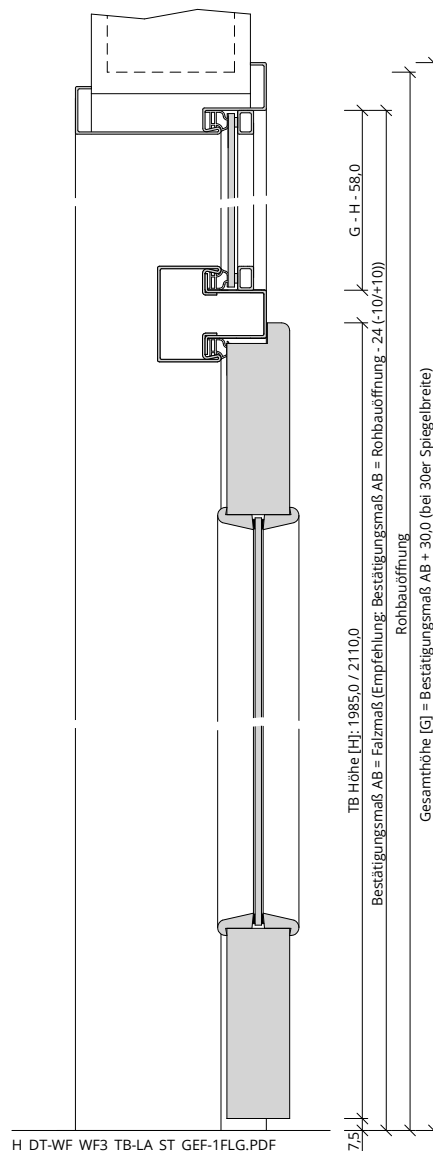