

A_DT-WF_WF3_TB-LA_FU_GEF-1FLG.PDF

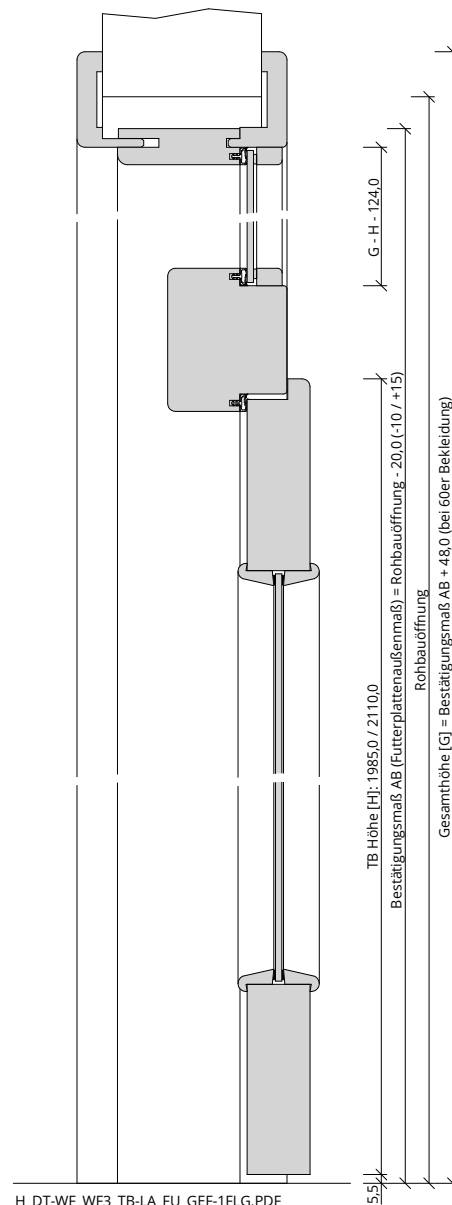

H_DT-WF_WF3_TB-LA_FU_GEF-1FLG.PDF

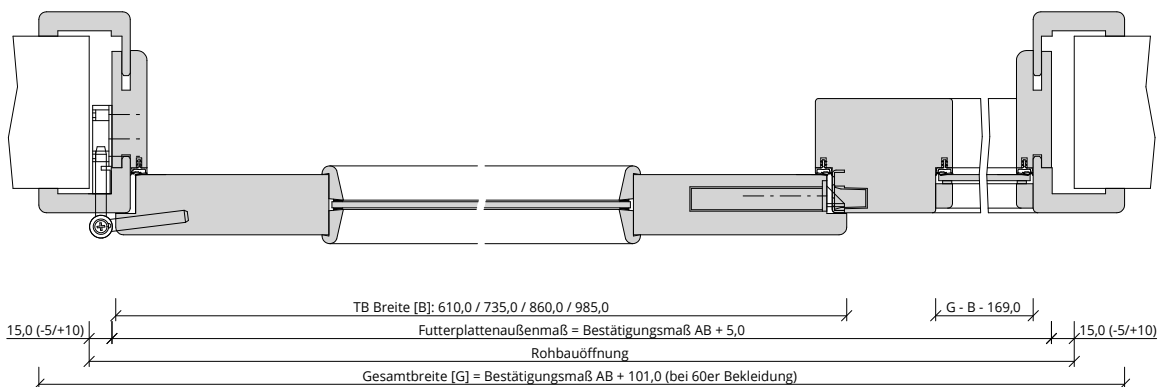

Q_DT-WF_WF3_TB-LA_FU_GEF-1FLG.pdf

