

A\_FS\_TB-BLO-1FLG\_WF4-V1\_STU\_FS-30-1-LA-RD.pdf

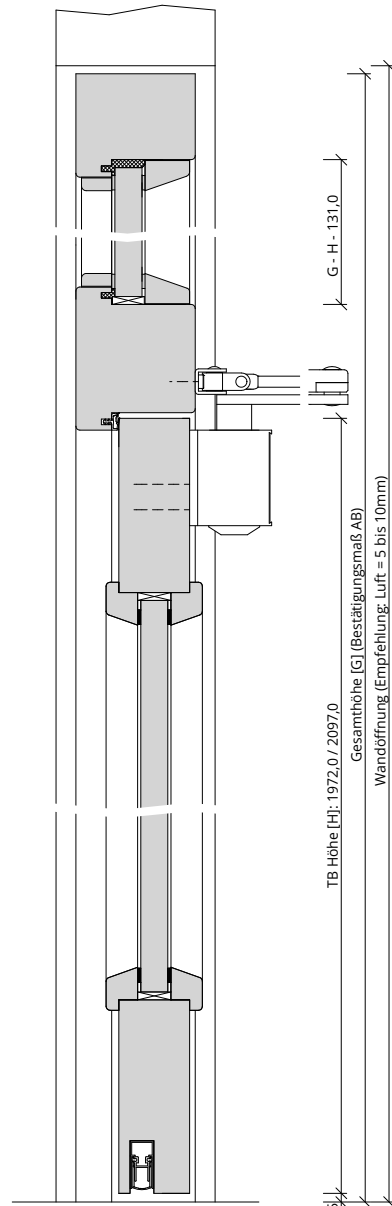

H\_FS\_TB-BLO-1FLG\_WF4-V1\_STU\_FS-30-1-LA-RD.PDF

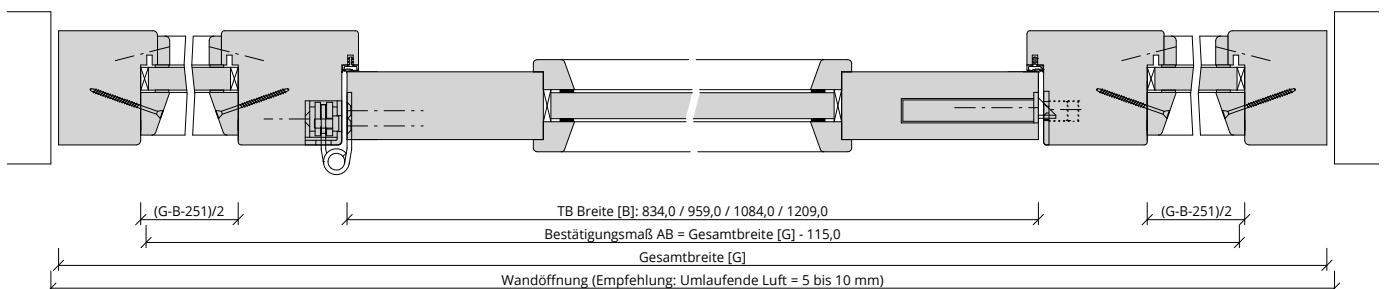

Q\_FS\_TB-BLO-1FLG\_WF4-V1\_STU\_FS-30-1-LA-RD.pdf

