

A_FS_TB-BLO-2FLG_WF4-V1_GEF_FS-30-2-LA-RD.pdf

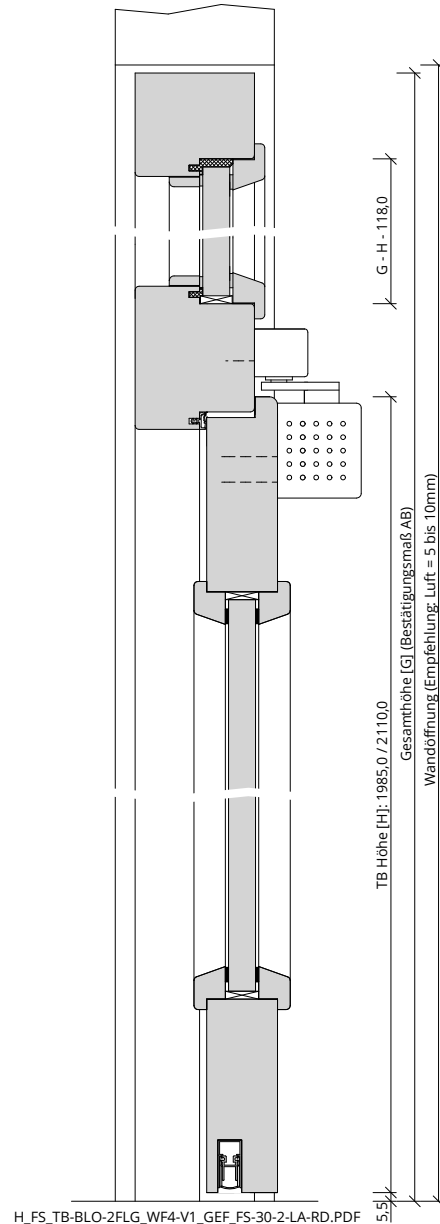

H_FS_TB-BLO-2FLG_WF4-V1_GEF_FS-30-2-LA-RD.PDF

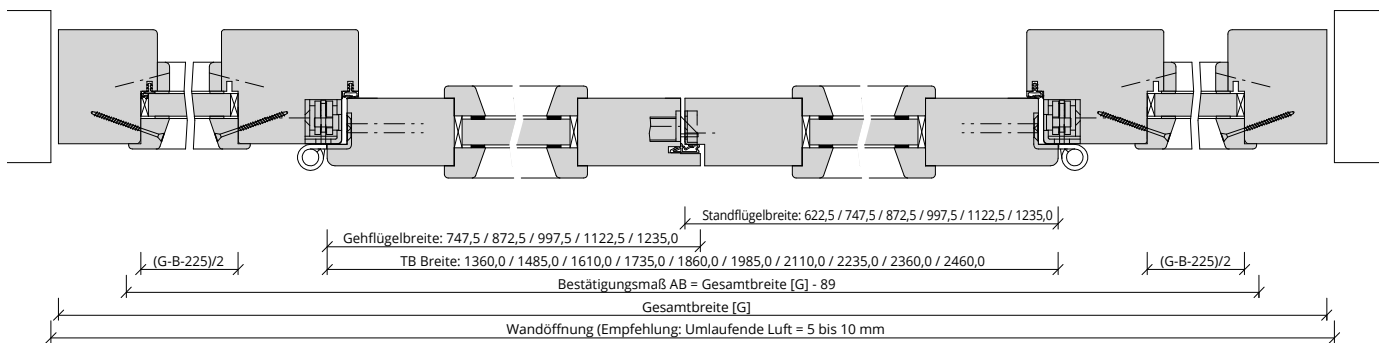

Q_FS_TB-BLO-2FLG_WF4-V1_GEF_FS-30-2-LA-RD.pdf

