

A_RD_TB-BLO-1FLG_WF4_GEF_RD-40-LA.PDF

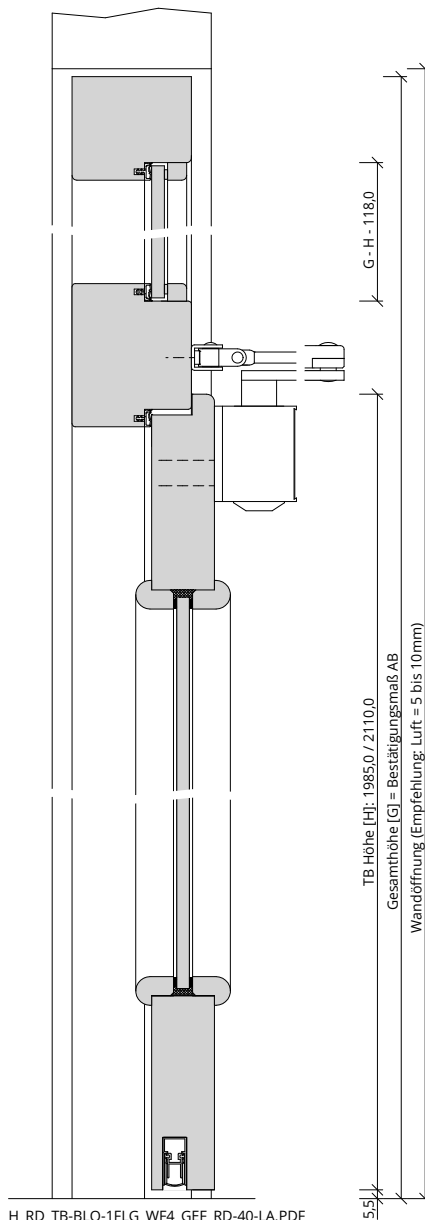

H_RD_TB-BLO-1FLG_WF4_GEF_RD-40-LA.PDF

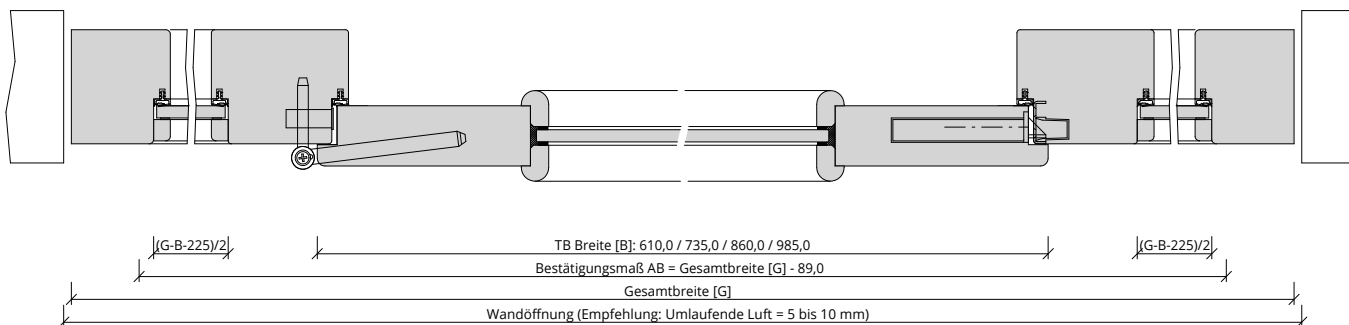

Q_RD_TB-BLO-1FLG_WF4_GEF_RD-40-LA.PDF

