

A_RD_TB-FU-2FLG_WF3_STU_RD-40-2-LA.PDF

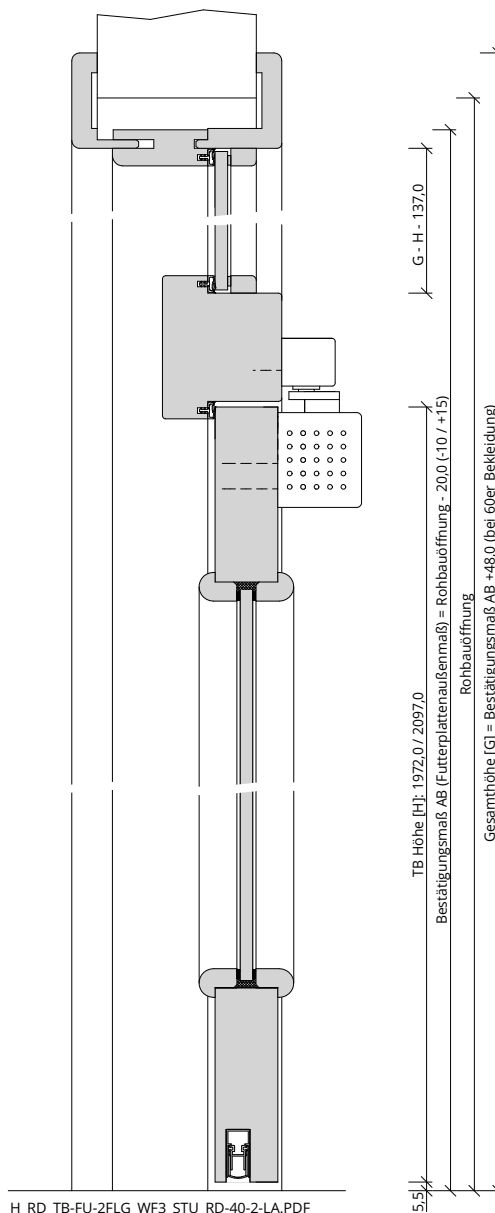

H_RD_TB-FU-2FLG_WF3_STU_RD-40-2-LA.PDF

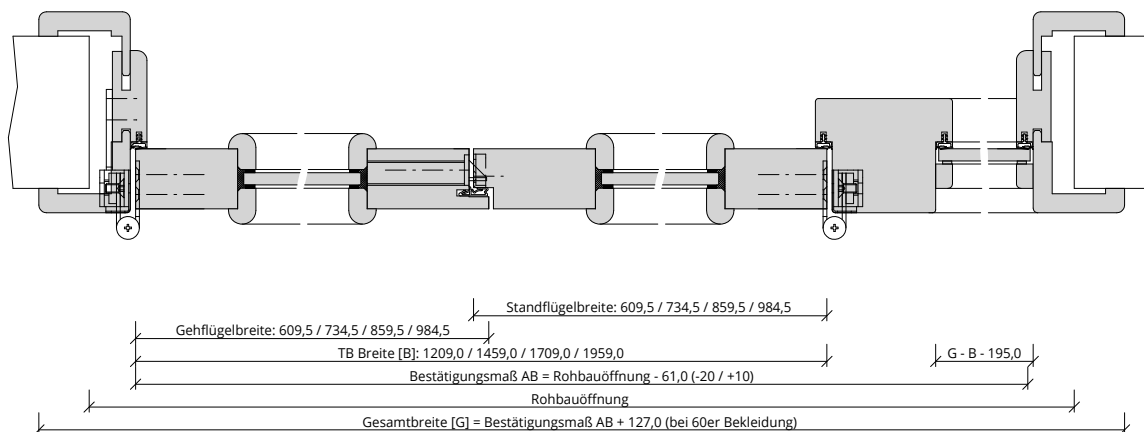

Q_RD_TB-FU-2FLG_WF3_STU_RD-40-2-LA.PDF

