

A_RD_TB-BLO-2FLG_WF1_GEF_RD-40-2.PDF

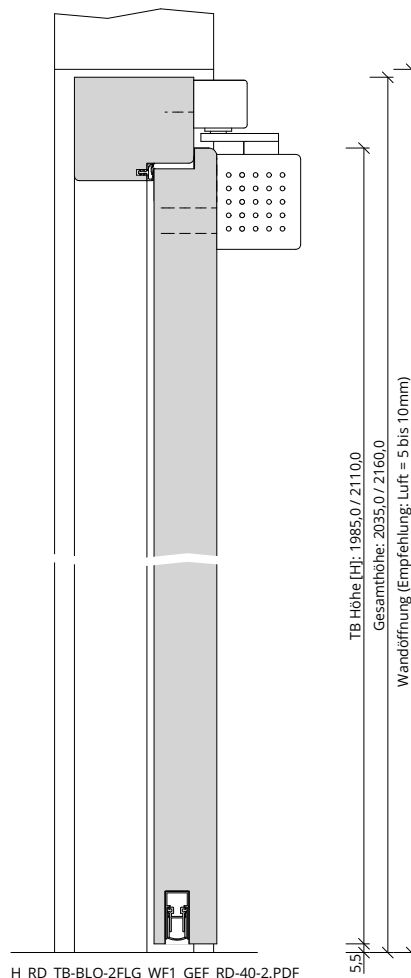

H_RD_TB-BLO-2FLG_WF1_GEF_RD-40-2.PDF

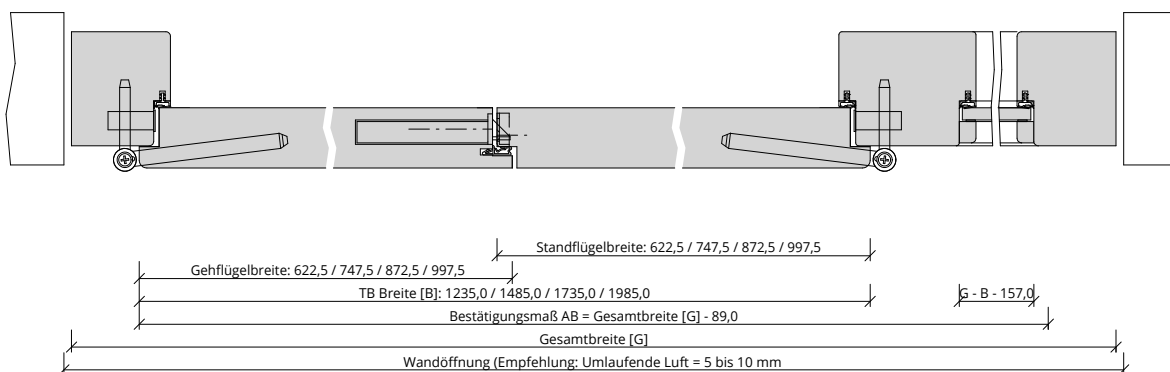

Q_RD_TB-BLO-2FLG_WF1_GEF_RD-40-2.PDF

