

WN 056460 45532, 10/19

Art. Nr. 13000100

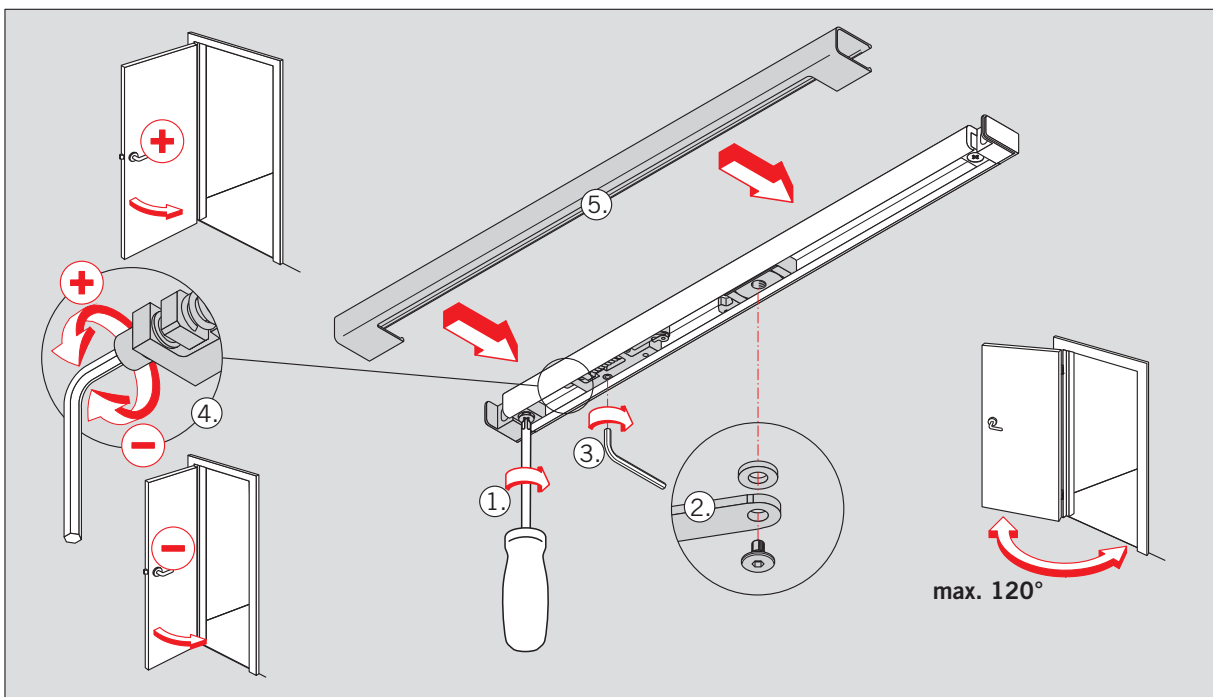
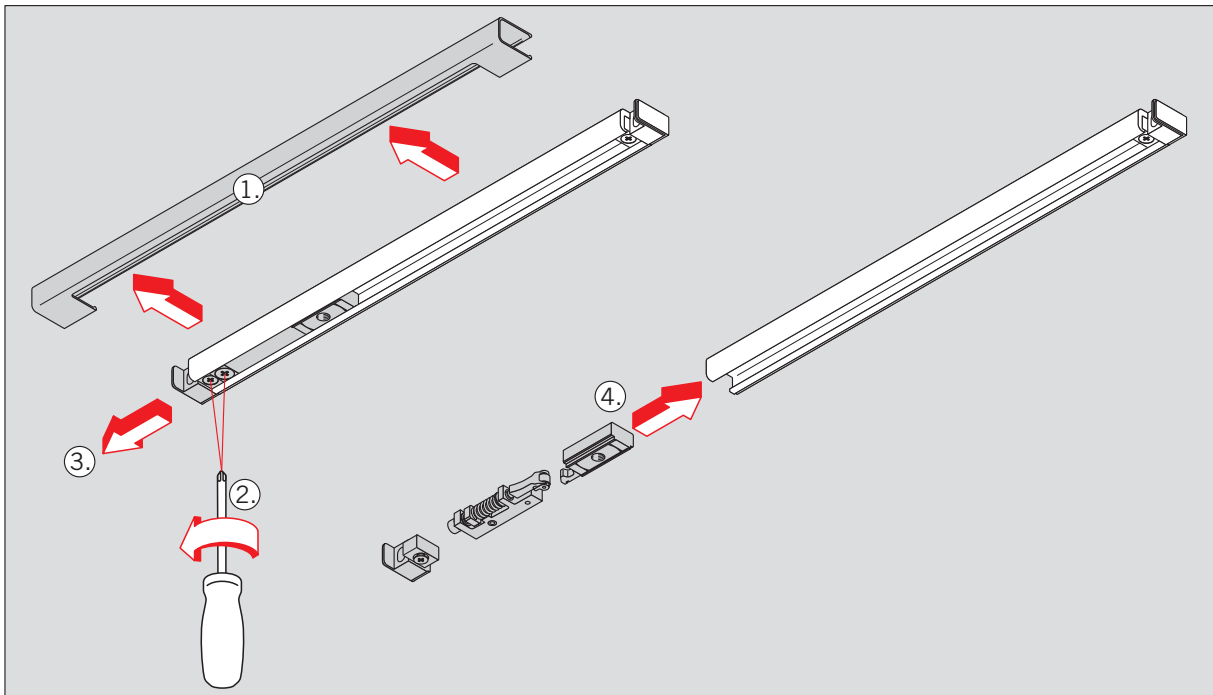
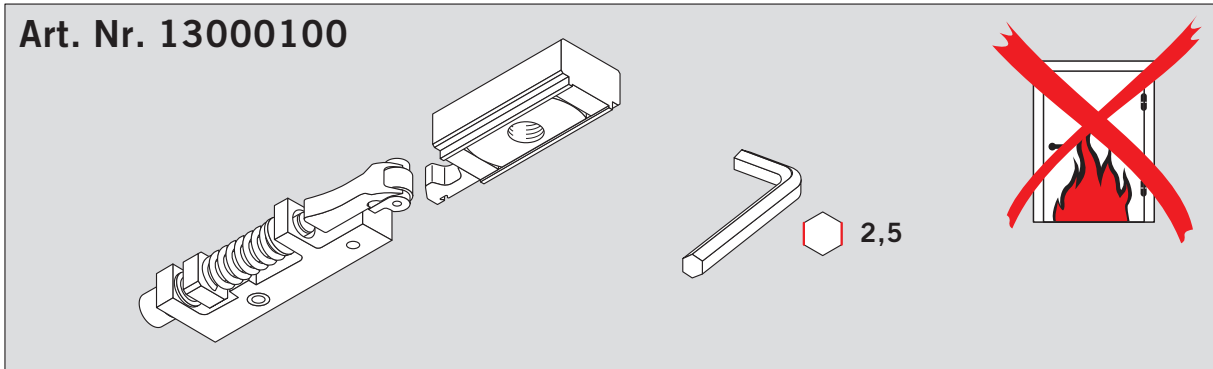

Änderungen vorbehalten
 Subject to change without notice